

TECHNOLOGY

टेक्नोलॉजी फोकस

FOCUS



An In-house S&T
Bulletin of DRDO

www.drdo.gov.in

Vol 30 | Issue 5 | October 2022 | ISSN No. 0971 - 4413

ELETROMAGNETIC RAILGUN



Technology Focus focuses on the technological achievements in the organization covering the products, processes and technologies.

October 2022

Vol. 30 | Issue 5 | ISSN No. 0971-4413

Editor-in-Chief: Dr K Nageswara Rao
Assoc Editor-in-Chief: Alka Bansal
Managing Editor: Ajay Kumar

Editor: Dipti Arora
Prepress: Raj Kumar

Printing: SK Gupta



Readers may send their suggestions to

The Editor, Technology Focus

DESIDOC, Metcalfe House

Delhi-110 054

Telephone: 011-23902403, 23902472

Fax: 011-23819151; 011-23813465

E-mail: director.desidoc@gov.in; techfocus.desidoc@gov.in; technologyfocus@desidoc.deldom

<https://www.drdo.gov.in/technology-focus>

Laboratory Correspondents

Agra	Shri SM Jain, ADRDE
Ahmednagar	Col Atul Apte, Shri RA Shaikh, VRDE
Ambarnath	Dr Susan Titus, NMRL
Bengaluru	Shri Satpal Singh Tomar, ADE Smt MR Bhuvaneswari, CABS Smt Faheema AGJ, CAIR Shri R Kamalakannan, CEMILAC Shri Kiran G, GTRE Dr Sushant Chhatre, MTRDC
Chandigarh	Shri Neeraj Srivastava, TBRL
Chennai	Smt S Jayasudha, CVRDE
Dehradun	Shri Abhai Mishra, DEAL Dr SK Mishra, IRDE
Delhi	Shri Sumit Kumar, CFEES Dr Dipti Prasad, DIPAS Dr Nidhi Maheshwari, DIPR Shri Navin Soni, INMAS Shri Anurag Pathak, ISSA Ms Noopur Shrotriya, SAG
Gwalior	Dr AK Goel, DRDE
Haldwani	Dr Atul Grover, DIBER Dr Ranjit Singh
Hyderabad	Shri ARC Murthy, DLRL Dr Manoj Kumar Jain, DMRL
Jodhpur	Shri Ravindra Kumar, DL
Kanpur	Shri AK Singh, DMSRDE
Kochi	Smt Letha MM, NPOL
Leh	Dr Tsering Stobden, DIHAR
Pune	Shri AK Pandey, ARDE Dr Himanshu Shekhar, HEMRL Dr Anoop Anand, R&DE(E)
Tezpur	Dr Sibnarayan Datta, DRL
Mysuru:	Dr M Palmurugan, DFRL

From the Desk of Guest Editor



Armament Research & Development Establishment (ARDE) is one of the earliest laboratories established under the DRDO umbrella. It has, as its mandate, the design and development of conventional armaments for the Services and Paramilitary Forces. To be at the level of world development and to meet the increasing requirement of highly accurate and high speed weapons with enhanced lethality that inflict low collateral damage, ARDE has established technologies and facilities for the development of Electromagnetic (EM) railgun.

There has been an ongoing effort to increase both the lethality and range of guns both in conventional field artillery, naval guns, and tank guns. Conventional powder guns, used in these applications have almost reached the limit of their range capabilities with limitations imposed by Physics, Maths than by technology. Performances of such guns are plateauing with possibility of only incremental improvements. In this situation EM railgun could be a 'game-changing' weapons of the future. The EM gun can revolutionise naval strike operations by delivering hypervelocity projectiles to pinpoint accuracies and extended ranges. Furthermore, the absence of energetic materials also eliminates the need for explosive safety standards for manufacturing, transportation, handling, and storage. Electromagnetic railgun technology is the unique and practical method for accelerating projectile to muzzle velocity beyond 2000 m/s, which conventional chemical propellant guns cannot achieve.

The railgun for decades has been languishing as a laboratory tool. However research efforts worldwide indicates that the technology is now maturing and moving from the laboratory to practical systems. A survey of existing literature on railgun indicates that there is a huge research effort ongoing in western countries, Japan, and China in hypervelocity railguns. It is very likely that railguns will move from laboratory prototypes to weapon platforms.

The initial research work related to EM gun at the laboratory was taken during 1983 to 1991. 5 kV, 240 kJ capacitor bank to power 12 mm railguns were developed and established.

To be at par with world development, ARDE successfully completed the ambitious S&T project on EM gun powered by capacitor bank. A 10 MJ railgun powered by capacitor bank has been successfully test fired with various bore sizes and projectile masses. The next level plan is weaponisation of the technology by developing a 100 MJ railgun. Steps in this direction have already been taken by establishing the 'Centre for Electromagnetic Launch Technology (CEMaLT) at ARDE.

This issue of *Technology Focus* brings out an introduction on the technology related to EM railgun and ARDE's contributions toward its development.

A Raju
Outstanding Scientist & Director
ARDE, Pune

ELETROMAGNETIC RAILGUN

Projectile accelerates in a conventional gun barrel due to propellant burning in the gun chamber. But there is a limit to how much propellant can be filled in the chamber of a gun. A gun requires a larger chamber volume to accommodate a higher amount of propellant resulting reduction in pressure. The maximum velocity with which the gases can accelerate the projectiles is a function of the speed of sound in the gas.

The gun propulsion techniques in the conventional weapon is summarised in Figure below.

phenomena travels with the speed of light.

Using programmable pulsed power technology, a railgun based on 10 MJ capacitor bank has been successfully designed, developed, and installed at ARDE, Pune. Hypervelocity propulsion of >2000 m/s has been achieved by using this facility. Using the 10 MJ EM railgun, a series of dynamic firing trials from a fixed firing stand was conducted for experimental evaluation and system performance. These experiments has helped to characterize EM railgun for different bore sizes up from 12 mm to 45 mm for

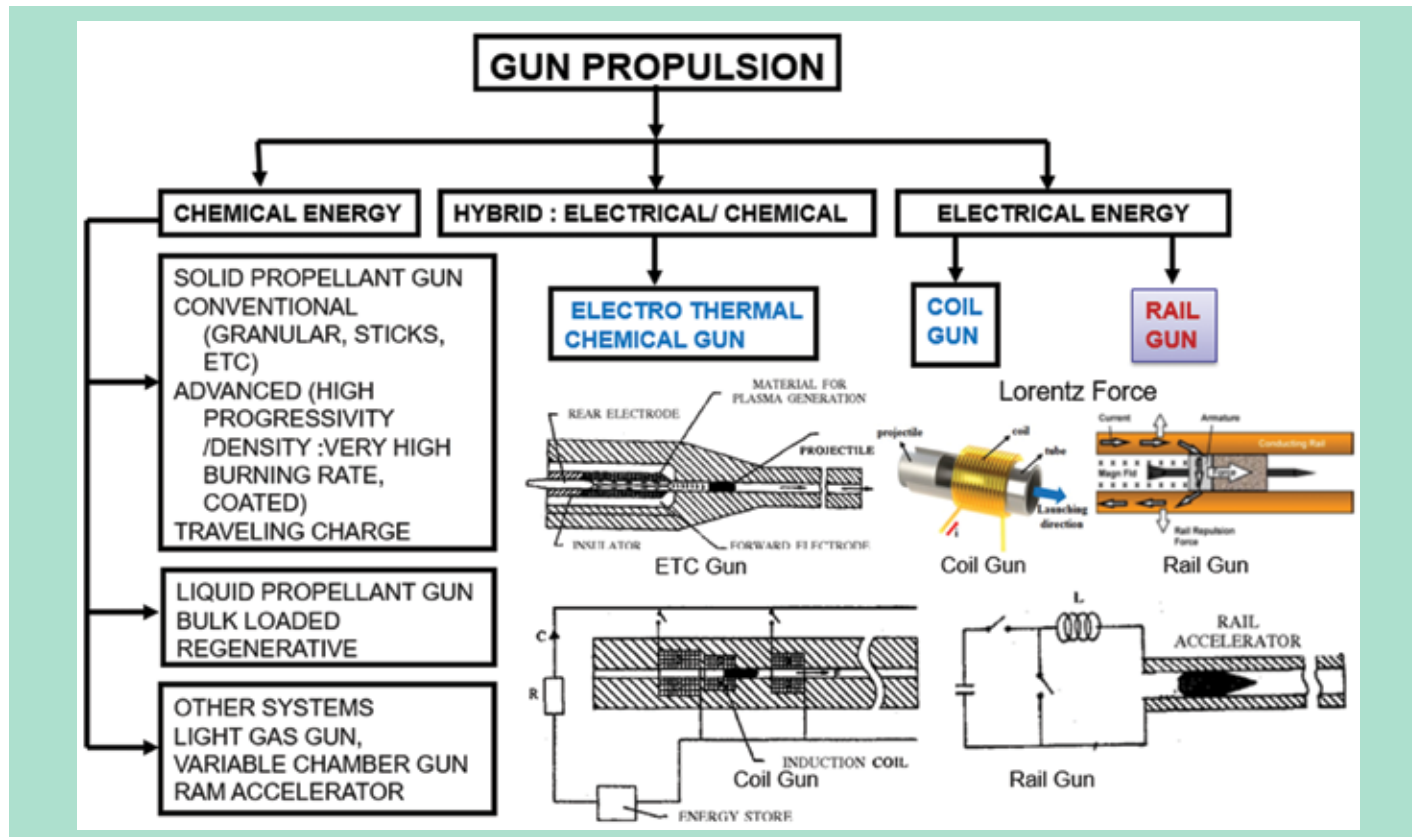

Gun Propulsion Technologies

Latest technology in the name of EM propulsion is being explored in which EM energy due to Lorentz force is used to propel a projectile. This type of propulsion system has no such theoretical limit of velocity of the medium unlike the gases in chemical energy-based propulsion; as electromagnetic

projectiles of 80 gm, 120 gm, 250 gm, and 500 gm. Based on the know-how gained after the successful completion of Technology Demonstration (TD) project, the configuration and design methodology can be extended to achieve higher speed, range, and lethality in futuristic rail gun.

EM Propulsion and Hypervelocity

Electromagnetic propulsion uses Lorentz force to accelerate projectiles. The principle is simple: a current-carrying conductor when placed in a magnetic field causes it to experience a force. The higher the current and magnetic field, higher is the force experienced by the conductor. In the case of a gun, this force has to be large enough to impart a high velocity in the limited length of the barrel (usually few inches to few meters) that is available.

Various forms of EM propulsion technologies are linear motor, coilgun, and railgun. Linear motor and coilgun technologies are good for accelerating large masses (few kg to few hundred kgs) to velocities in the range of 100 m/s to 1200 m/s beyond which there are practical limitations to achieve a higher velocity and thus not suitable for weapon grade gun development programmes. Railguns on the other hand can accelerate projectiles of shot size masses to beyond 2000 m/s thereby achieving the hypervelocity propulsion. Such hypervelocity has many advantages such as increased lethality, increased range, and increased standoff distances. Increased velocity also means that railgun technology can be used against close-in-defence against missile and aircrafts as a direct fire weapon. Railguns further have advantages that the logistics including storage and transportation of ammunition become simple and hazard free because of absence of propellants. The cost of maintenance and firing per round will be much lower compared to conventional chemical propellant-based gun systems. There are almost negligible recoil, blast, and flash signatures and hence these weapons can be adapted to various launch platforms and terrain conditions.

Principle of EM Railgun Operation

The principle of railgun is simple, there are two parallel conductors (called rails) as the stationary part and a moving contact called armature. When a large current is passed through one rail, the armature conducts the current to the second rail. The EM field created by the rails causes the projectile (armature) to move in forward direction along the rails/barrel due to Lorentz force.

The force on the projectile is given by: $F = \frac{1}{2} L' I^2$, where L' is the inductance gradient of the rails (inductance offered to the path of current in the rails per unit length) and I is the current in the rails. Thus for the gun to achieve such high velocities the current to be injected in the gun is in Mega Amperes (MAs).

Designing and developing system and technologies for handling such high power is a challenging task in terms of ratings of the components, isolations, and operational built-in safeties. With the development in the semiconductor technologies and availability of high energy density capacitors, the design and development of a gun system based on EM propulsion could be made feasible.

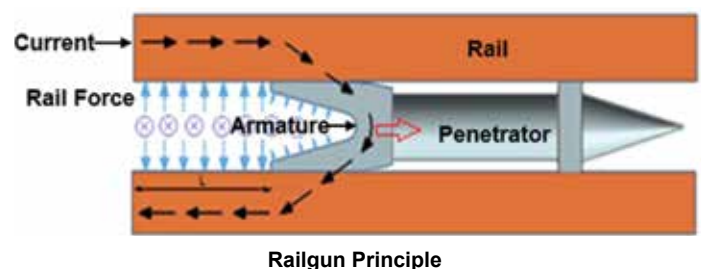

EM RAILGUN AT ARDE

Pulsed Power System

When it comes to weapon applications, energies of the order of Mega Joules (MJ) and power of the

order of Giga Watts (GW) are required. Pulsed power systems are energy sources that can deliver large

amounts of energy in a very short time duration of a few microseconds to a few milliseconds. Some of the contenders of pulsed power sources are batteries, super capacitors, inductors, compulsators, and thin film capacitors.

At ARDE, thin film capacitors are being used. These capacitors are arranged in modules of 400 kJ each to regulate the amount and shape of the current pulse injected into the railgun. The CAD model of the modules in the 10 MJ capacitor bank is as shown in Figure.

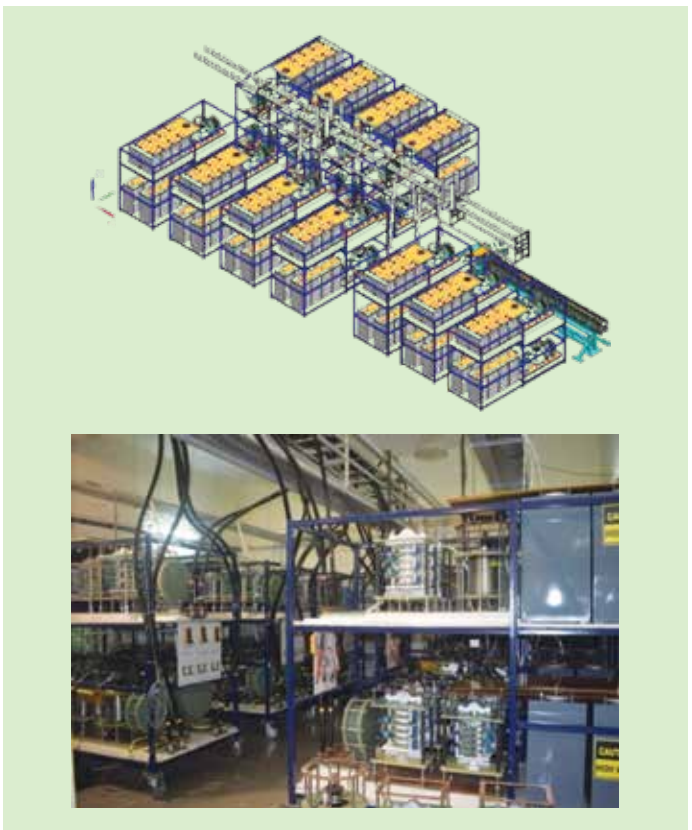

CAD Model and Realized 10 MJ Capacitor Bank

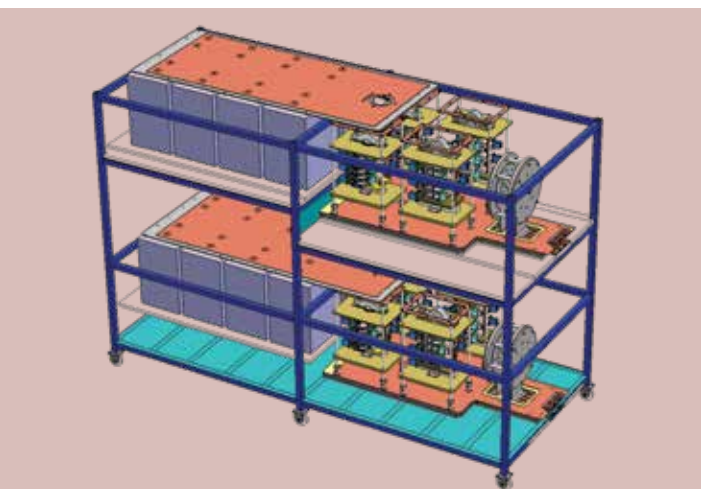

CAD Model and Realized Capacitor Bank Module Arranged on a Rack

The CAD model of the modules arranged to form 10 MJ capacitor bank is also shown in Figure.

Each module contains capacitors in parallel (C_o), a switch, an inductor (L_o) to limit the current and shape the pulse, a freewheeling crowbar switch (D) to avoid oscillations. Figure shows the electrical representation of the capacitor bank circuit being used at the laboratory and corresponding hardware

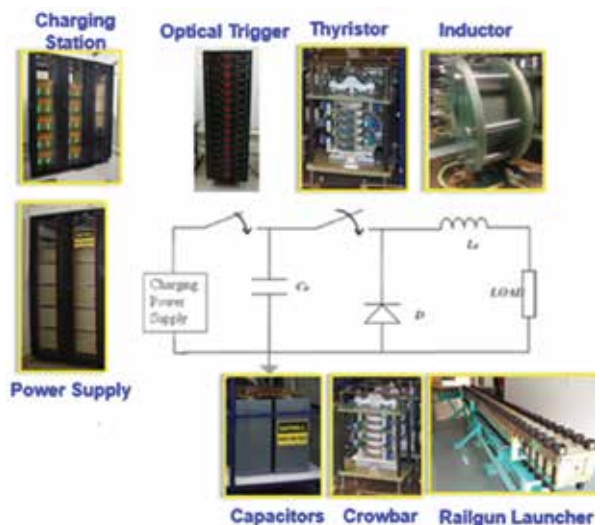

Railgun Circuit Representation

to realise the same along with railgun as load. Initial switching were carried out using ignitrons, however some of the ignitrons are now replaced by semiconductor switch assemblies. The pulse shaping inductor is of solenoid design in the form of stacked flat plates named as Bitter Coil. The various subsystems have been developed at the laboratory.

Railgun

The railgun experiences large repulsive forces and thus a containment structure has been designed for minimum rail deflection. The rails are also subjected to damage through armature movement along its surface. Railguns upto 45 mm bore have been developed in the laboratory. The design of the railgun and the railguns developed are shown.

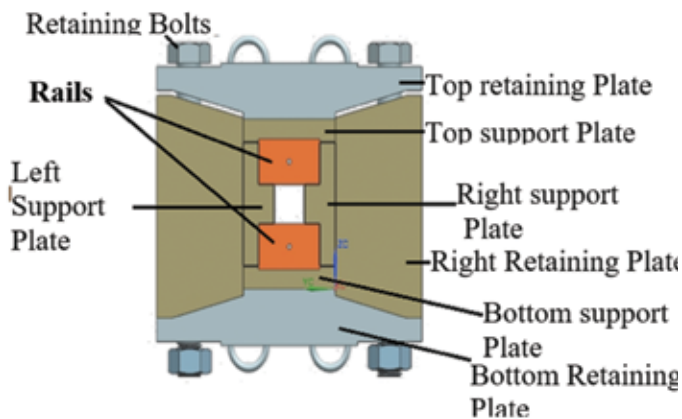

Railgun Design

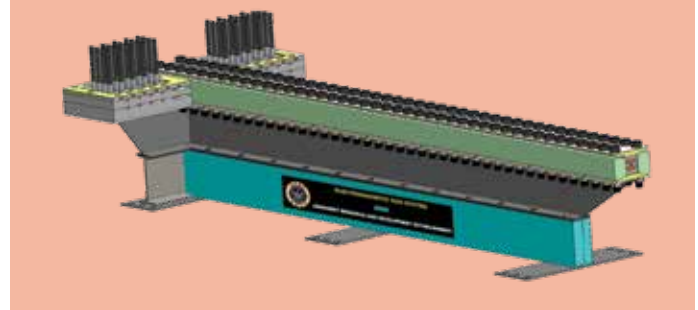

Railguns upto 45 mm Bore

Projectiles

A specially designed C-shaped armature has been used to complete the high current path with the rails. The C-shaped armature also carries the projectile. Up to 1 kg projectiles have been fired from the 45 mm EM railgun. Some of the projectiles are tried at the laboratory.



Railguns upto 45 mm Bore

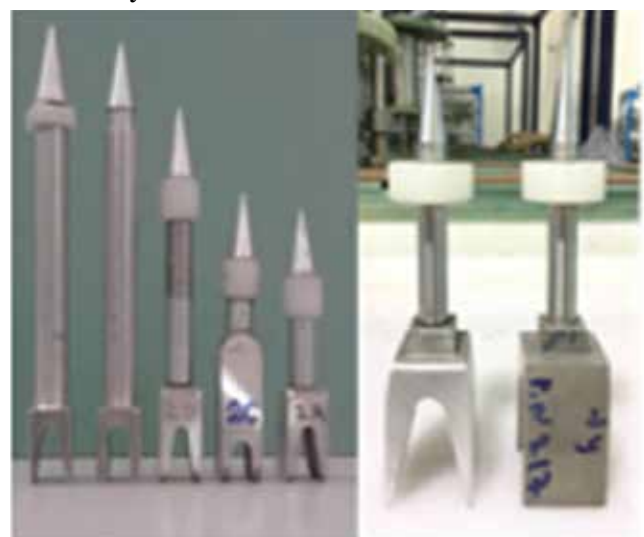

Armature with Penetrator

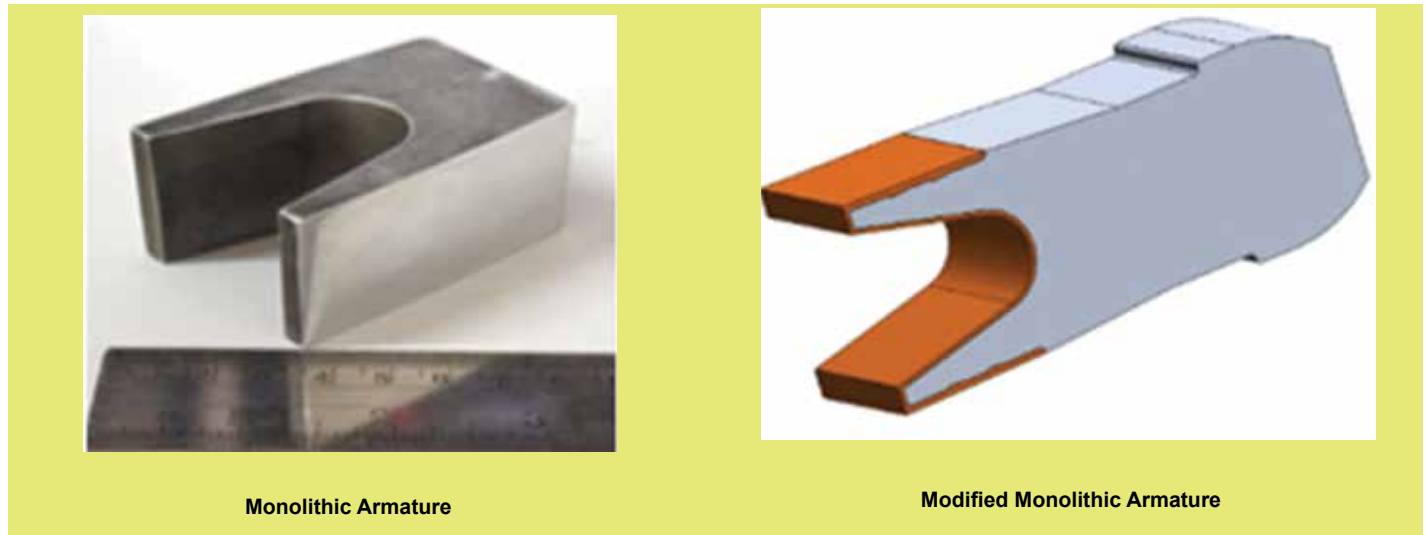

Projectiles

Design, Analysis, and Simulation

In the simulation, a number of modules are switched together and known as one segment. Thus the whole capacitor bank of 25 modules (10 MJ) has been divided into a number of segments and each segment was switched at a particular time by incorporating

delay into switching times of the main switch. Main objective of sequential switching is to obtain a flat top current pulse. Iterative simulations are carried out to evaluate suitable segment size and switching time. A simulation case in microcap is shown in Figure. For this case, the modules are divided into three segments at different time intervals.

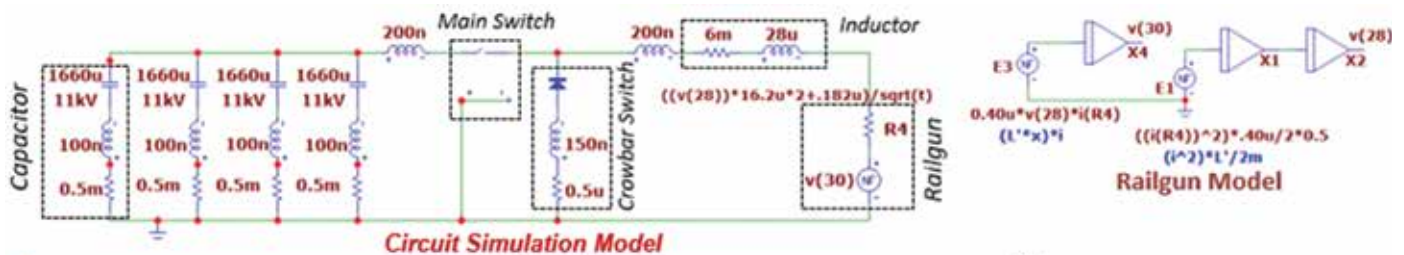

Circuit Model (Developed in Microcap)

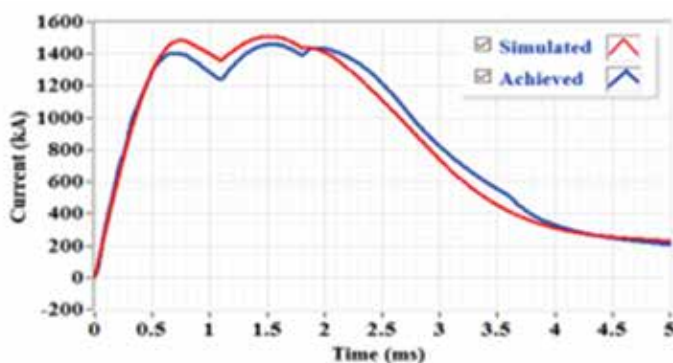

Simulated V Actual Current Profile

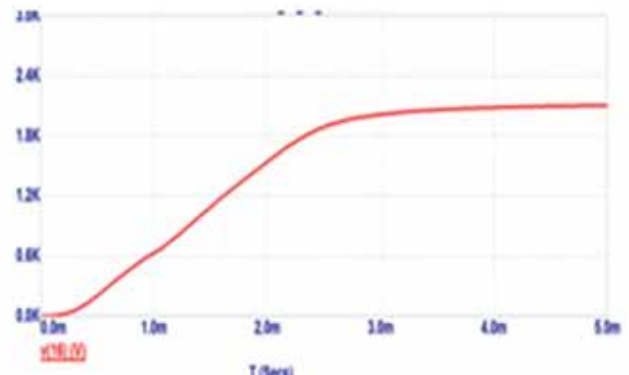

Velocity Profile

Circuit Simulation Results 10 MJ Capacitor Bank

The simulation models (Red) developed has been validated against actual firing results (Blue). Simulations have been carried out to design pulsed power components using Maxwell & ANSYS workbench for different configurations of railgun

sizes, armature, and bitter coil. Complete EM and structural study is carried for proper evaluation of the systems. The current density, force, stresses, temperature rise, etc. are evaluated using FE simulations. The simulation are as shown in Figures.

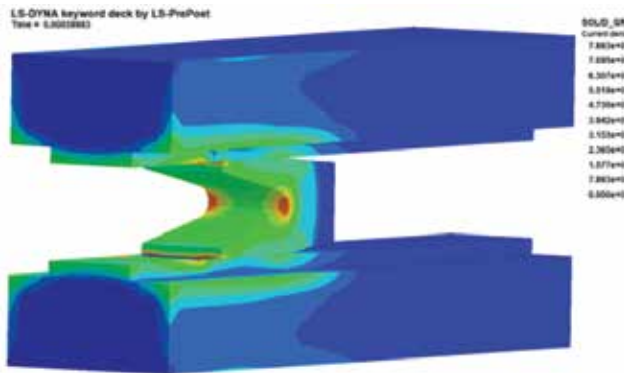

Current Density in Rail gun

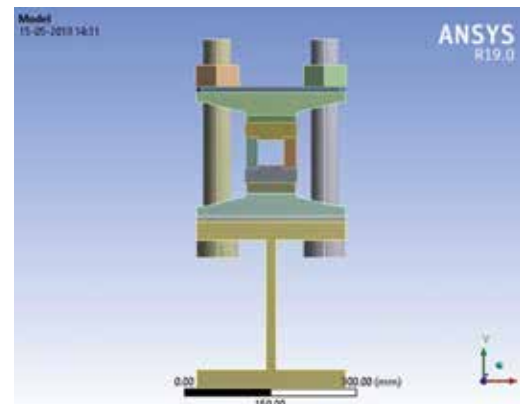

Rail Deflection Analysis

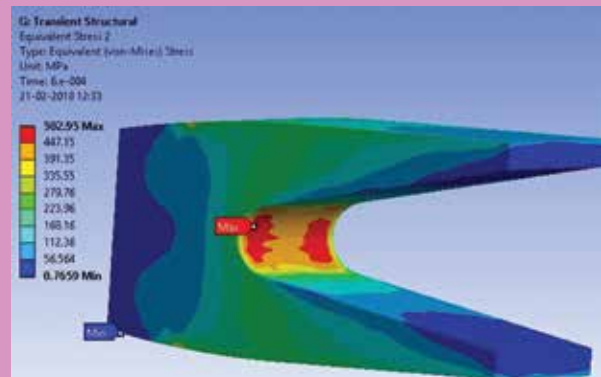
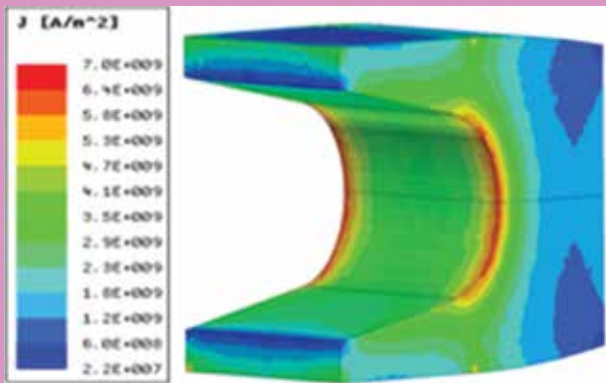

Armature Analysis

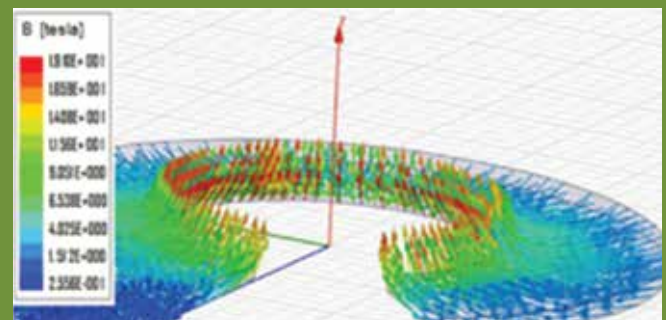
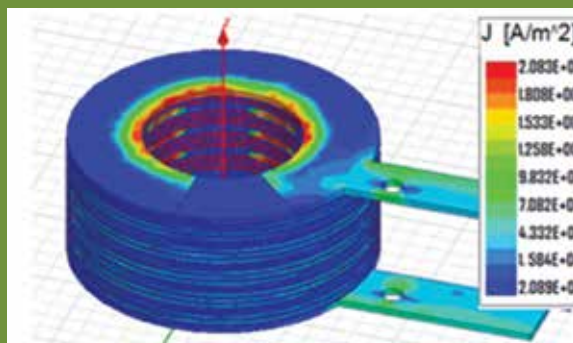

EM Analysis of Bitter Coil

Instrumentation and Control of EM Railgun

Various sensors have been developed in-house for monitoring and analysis of the system which has helped to develop EM railgun. Rogowski coils have been developed in-house to measure module currents,

B-dots for the measurement of in-bore velocity of the projectile and differential probes for the Breech and Muzzle Voltage measurement.

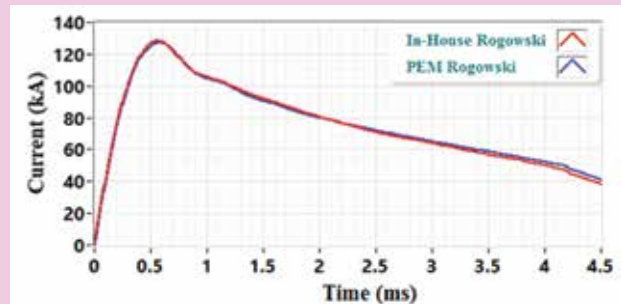

Rogowski Coil and Current Profile

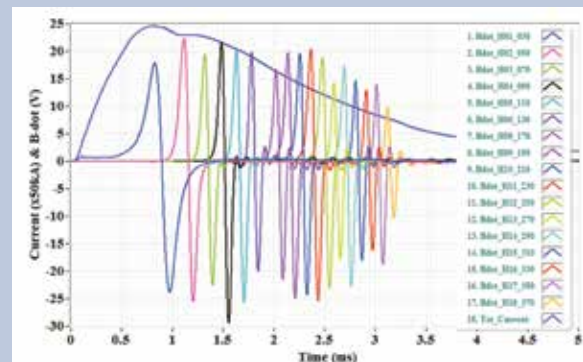

B-dot Probe and Measurements

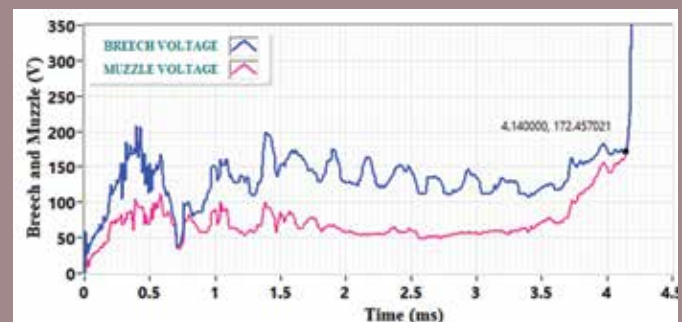

Breech and Muzzle Voltages

The instrumentation layout for complete railgun system using the sensors is shown in Figure. Data from more than 100 Nos of sensors is acquired through multiple different oscilloscopes to capture and analyse the performance of the 10 MJ railgun system. For capturing and analysis of the data for more than 100 channels of data, a Data Acquisition System (DAS) software using NI Labview has been developed. The main interface of the DAS system is shown. The DAS software provides the capabilities such as configuring, acquisition, and storage of data from multiple oscilloscopes and scope corders, also analysis and display of data.

The EM railgun operates at a high voltage and high current environment and, utmost safety cautions are to be taken during operation of the system. A PXI-based control system provides individual control for charging and discharging of each module, triggering the capacitor bank modules and controlling the power supplies. The PXI-based control system controls more than 100 No of channels for 25 No of modules and has robust control mechanisms with built-in safeties during the operations. To perform the action involved during the firing of the railgun, a PXI control system software has been designed using NI Labview to control the operations remotely. The software provides the capabilities for controlling, monitoring and triggering all the modules in the 10 MJ railgun system from a single interface window. The software interface developed for the control system using Labview is shown in Figure.

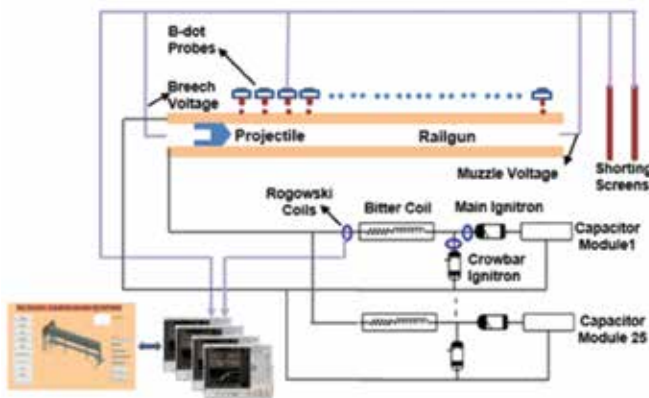

Instrumentation Setup

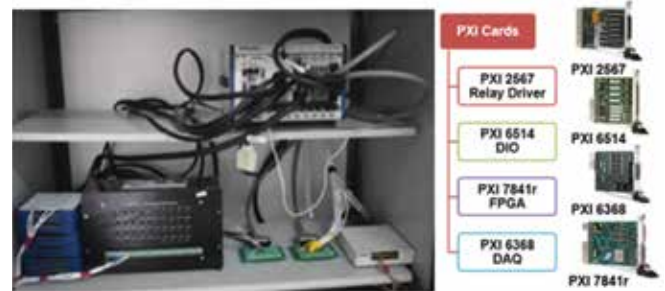

PXI System



Data Acquisition System Main Interface



PXI Control System Interface

Firing Range and Trials

The EM railgun projectile has a special arrangement to catch the projectile. This is shown in Figure.



Projectile Arrestor

The image of the rail-gun during the firing of projectile is as shown in Figure and the captured image of the projectile after exiting the railgun using high-speed photography is also shown.



Railgun Firing

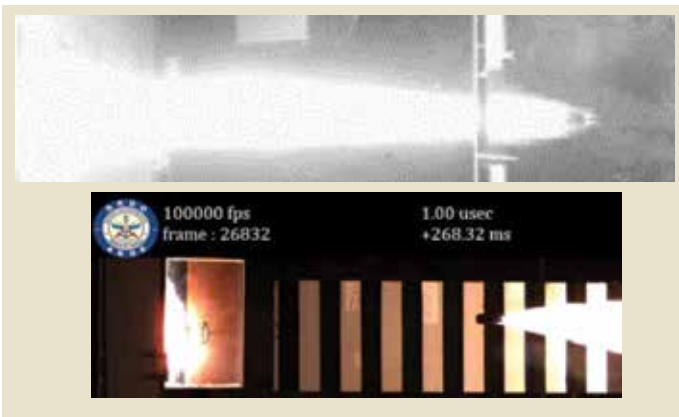

High-speed Photography for Velocity Measurement

The velocity measurement is done through shorting screens placed at a fixed distance as shown. The velocity is also measured from the B-dot probes placed along the length of the railgun and is also calculated using high-speed photography by using the frame rate and the distance between the selected locations where the projectile passes through.

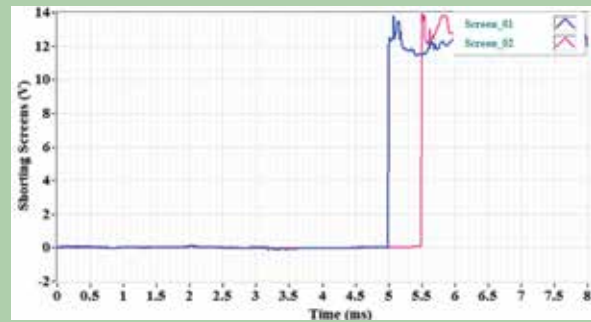

Shorting Screen Setup

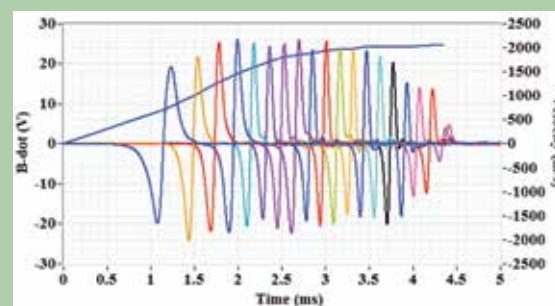

Velocity Profile using B-dot Probes

Some of the highlights from the trials are as follows:

Sr No	Bank Energy	Rail-gun Parameters	Projectile Mass	Muzzle Velocity
i	4 MJ	Bore- 30mm, Length-4m	120 g	2030 m/s
ii	6MJ	Bore- 45mm, Length-4m	250 g	2220 m/s
iii	10 MJ	Bore- 45mm, Length-4m	500 g	2123 m/s
iv	10 MJ	Bore- 45mm, Length-4m	1 kg	1660 m/s

Technologies Realised



EM Railgun Subsystems Designed and Developed

Subsystems	Designs	Subsystems	Designs
<p>Capacitor-based Pulsed Power System</p>		<p>Charging Station</p>	
<p>HV Cables and Connectors</p>		<p>Design, Simulation, and Analysis</p>	
<p>Rail-gun Launcher</p>		<p>Control System</p>	
<p>Isolated Optical Trigger System</p>		<p>Special Instrumentation</p>	
<p>Projectile Design and Development</p>		<p>Data Acquisition System</p>	

100 MJ EM Railgun

The technological advances gained in 10 MJ EM railgun development programme is being used to design, develop, and install an EM railgun to launch a 18 kg projectile at hypervelocity exceeding 2000 m/s powered by a 100 MJ capacitor bank from a fixed firing stand. Railguns suitable for large calibre up to 155 mm and medium range guns (100 km to 400 km) will be developed and test fired, thus bridging the gap between conventional guns and missiles. To launch projectiles at such large distances electrical

energy needed as input is very large (100 MJ). The gun system will be field worthy with multi-shot, traverse, and elevation capabilities. The development of EM railgun weapon systems will give an edge to the Armed Forces in the battlefield and prove as game changer. It is imperative to develop new areas of technologies which have clear advantages over conventional technologies. The development will be carried out at a dedicated infrastructure facility 'CEMaLT' (under development).

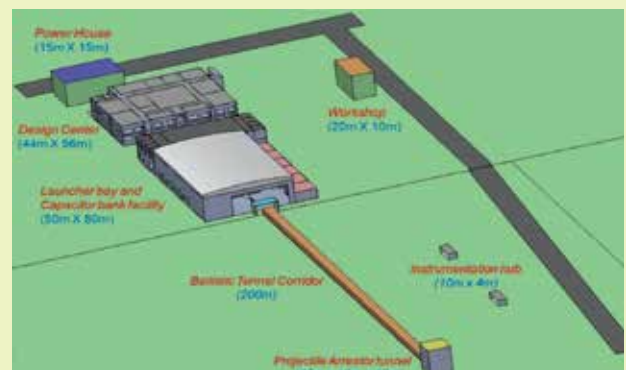
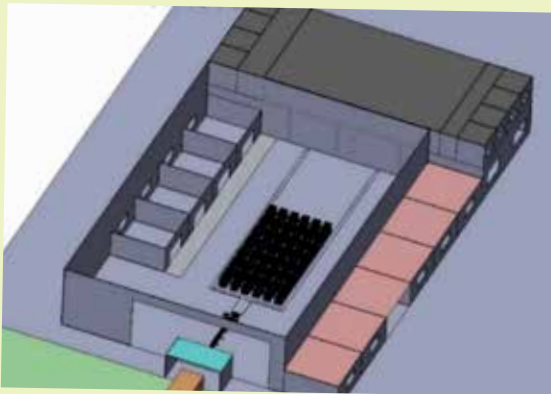

CEMaLT Infrastructure Facility for 100 MJ

The layout of the 100 MJ EM Railgun is shown below:

the gun. A futuristic ground-based installation of EM railgun is shown in Figure.

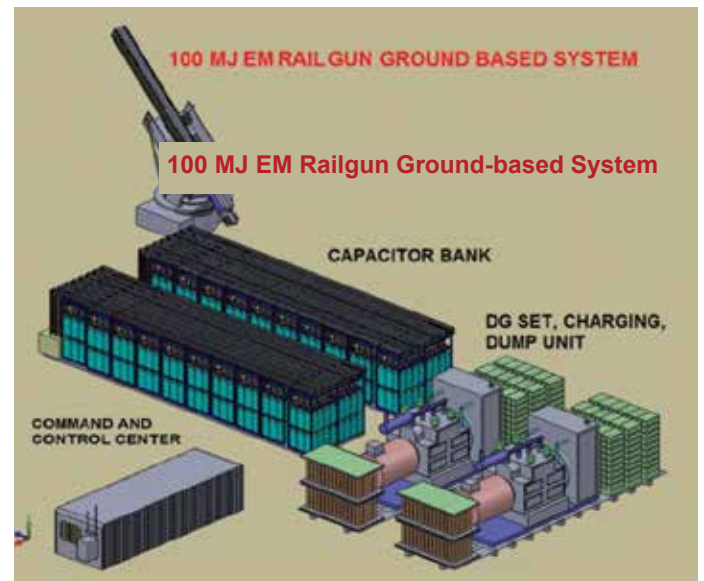
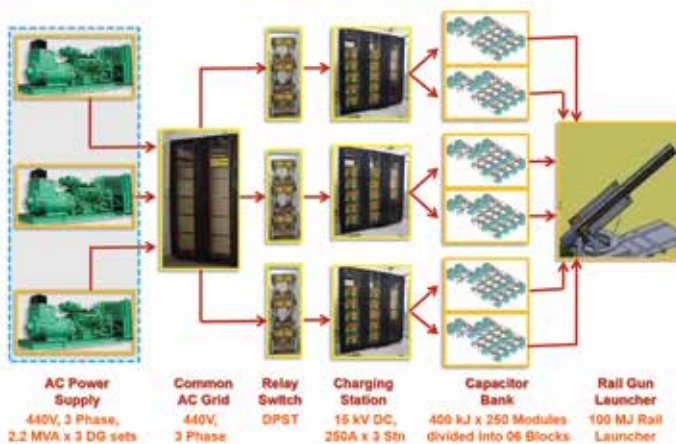

The future trend in EM rail-gun system will be to develop mobile systems with multiple firings from

Editors are thankful to Shri SK Nayak, Sc 'G' and his team for preparing the write-up for this issue of Technology Focus.

DRDO Monograph/Special Publication Series

ENDEAVOURS IN SELF-RELIANCE

DEFENCE RESEARCH (1983 - 2018)

A successor volume of
Defence Research and Development Organisation
(1958 – 1982)

Price: INR ₹ 2100

US \$ 75

UK £ 65

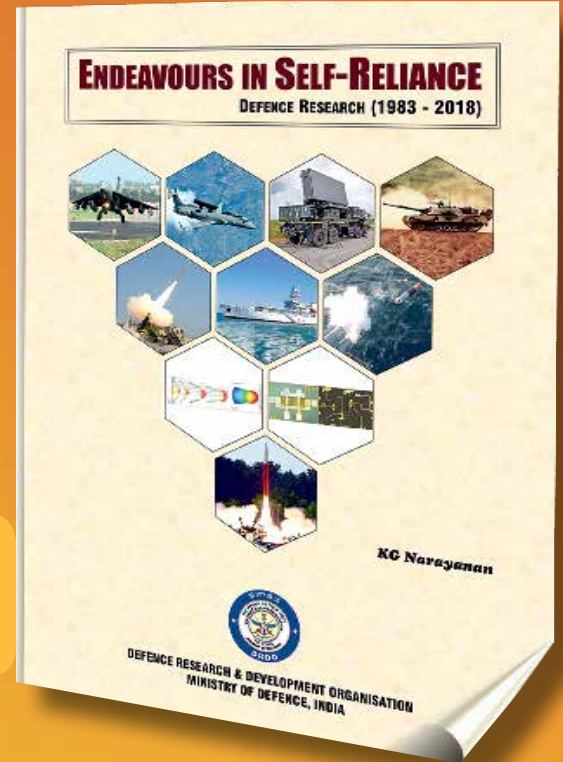

A Special Publication titled “Endeavours in Self-Reliance–Defence Research 1983-2018” was released formally by the Honourable Raksha Rajya Mantri, Shri Ajay Bhatt on the National Technology Day, May 11, 2022 at DRDO Bhavan, New Delhi. This is a successor volume of the book “Defence Research and Development Organisation (1958 – 1982)” by Dr RP Shenoy, published by DESIDOC, DRDO earlier.

This Special Publication covers the period 1983-2018 which were decades of explosive growth and achievements in the history of DRDO. Through the efforts scientists, soldiers, and policy makers in a single generation, indigenous capabilities in strategic weapon systems, guided missiles, aeronautical systems such as fighter aircraft and aerial early warning platforms, main battle tank, naval platforms, sensors and weapons, radars, communication systems, electronic warfare capabilities and numerous other equipment made huge leaps upwards. This Publication describes the Himalayan efforts made by the laboratories, establishments and programmes under the aegis of Department of Defence Research and Development, India, from the perspective of a historical account. The book was edited by Dr KG Narayanan, former Chief Adviser DRDO.

For Purchase, contact:
Director, DESIDOC, Metcalfe House, Delhi-110 054
marketing.desidoc@gov.in
011-23902612

डेसीडॉक द्वारा प्रकाशित

Published by DESIDOC

RNI No. 55787/93